

ELKA Housings made of aluminium

Customized configuration



Housing PKW 1200-v2.0



Housing PKW/LKW 2400-v2.0

Notes for the configuration

With the help of this configuration sheet, we would like to make the customization of our aluminium-housings as simple as possible. It is carried out as follows:



Installation service

In the first step you have the possibility to use our installation service. In addition to the wide range of ELKA installation items, we would be pleased to install your provided items into the housing during production. Alternatively we can make cut-outs, so that you can easily and quickly install your equipment on site.



Service-doors

If required by the installation situation, you can freely choose the position of the door. Furthermore a second door can be installed in each housing of the top and bottom part. In the case of the PKW/LKW-housing, the door of the top part cannot be installed above the front panel of the bottom part.



Shelf

Upon request, a shelf can be installed in the housing, e.g. for your additional accessories. In the case of the PKW/LKW-housing, a shelf can be installed in both, the top and bottom part.



LED lighting

For LED lighting, you can choose between the colours warm white (standard), red, green, blue and cool white. For connection, simply clamp the respective strands of the LED strip on the power supply.



Custom colours

All components of the housing can be individually painted in all RAL colours. The paint is applied as a wet paint over the existing powder coating.

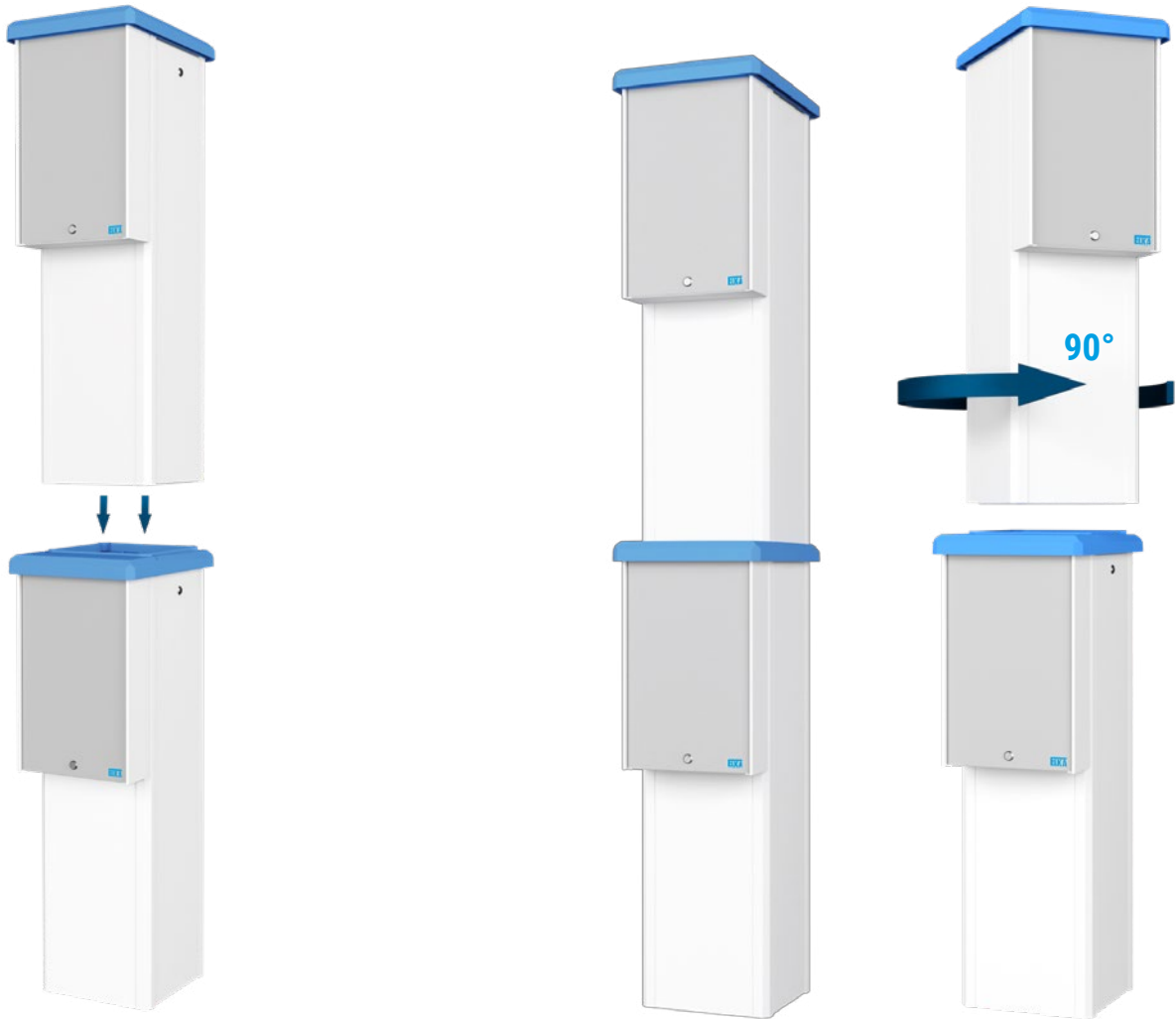

Top and bottom part

First, customize the bottom part of the PKW/LKW housing, followed by the top.

If you wish to customize a PKW housing, please use only the fields for the bottom part.

Note:

A PKW/LKW-housing can also be made on site from two PKW-housings. For this, you need the optionally available intermediate cover.

On-site installation











The top and bottom parts of a PKW/LKW-housing are packed separately. This makes it possible to transport up to 6 PKW- or 3 PKW/LKW-housings on one Euro pallet. The top part can be mounted on the bottom part on site, rotated in 90° steps.

Note:

For the PKW/LKW-housing, the door of the top part cannot be above the front panel of the bottom part. Please adjust the position of the door for rotated mounting in your order.

Installation service bottom part, optional

Please indicate the amount and the position per item:

	Item no.	Type	Amount	Spacing from left / spacing from the top edge
	608 000 002	Key switch STUP, flush mounting with cylinder and 3 keys		
	608 000 006	Key switch, STAZ, OPEN-CLOSE, flush mounting with cylinder and 3 keys		
	608 000 015	Key switch, STR, one-side lockable, flush mounting e.g. for CONSTANT OPEN, with cylinder and 3 keys		
	608 000 012	Key switch, STTR, impulse and lockable, flush mounting e.g. for CONSTANT OPEN or CONSTANT CLOSE, with cylinder and 3 keys		
	608 004 000	Token acceptor, mechanical for 1 token 25mm with grooves		
	608 006 001	Additional keyboard for code switch with stainless steel keypad, vandalism protected For further accessories see price list page 64		
	608 007 000	Magnetic key reader, flush mounting with 2 keys		
	608 002 000	Card reader ZUKO ID ZK/A contactless card reader with integrated antenna, for 199 transponder-cards For further accessories see price list page 68		
	608 002 006	RFI reader 80 IP 65, decoder RFI 1000 required For further accessories see price list page 68		
	608 008 021	IP video intercom system for car access, made of aluminum, modular construction with 4 interchangeable function modules, built-in camera for image transmission, with illuminated labeling field		

 Further accessories can be found in our price list.

Installation service bottom part, optional

Have ELKA items installed:

Please specify item and position:

Item: _____, spacing from the top edge: _____, spacing from left: _____

Item: _____, spacing from the top edge: _____, spacing from left: _____

Have provided item installed (without wiring):

Item: _____, spacing from the top edge: _____, spacing from left: _____

Item: _____, spacing from the top edge: _____, spacing from left: _____

Have a cutout made:

Dimension of cut-out 1: _____ (width x height or diameter),

spacing from the top edge: _____, spacing from left: _____

Dimension of cut-out 2: _____ (width x height or diameter),

spacing from the top edge: _____, spacing from left: _____

Note:

- Installation depth 400mm
- Distance between the cut-outs min. 10mm
- Cut-out with custom shape (e.g. logo) upon request

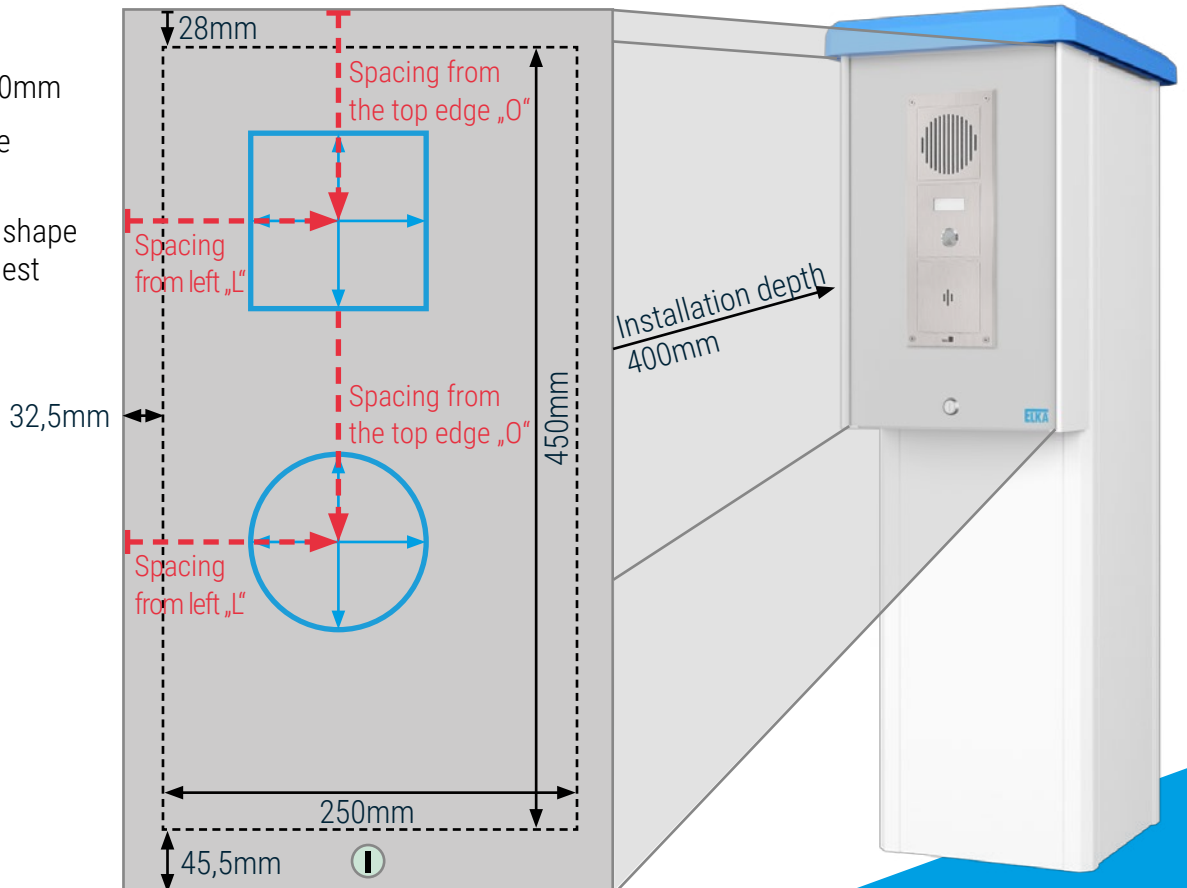

Service-doors bottom part



Standard lock



Swivelling lever lock

1. Door, standard:

Indicate the door position:

- left (Standard position)
- right
- rear

Choose a door lock:

- Standard lock
- Swivelling lever lock, optional

2. Door, optional:

Indicate the door position:

- left
- right
- rear

Choose a door lock:

- Standard lock
- Swivelling lever lock, optional

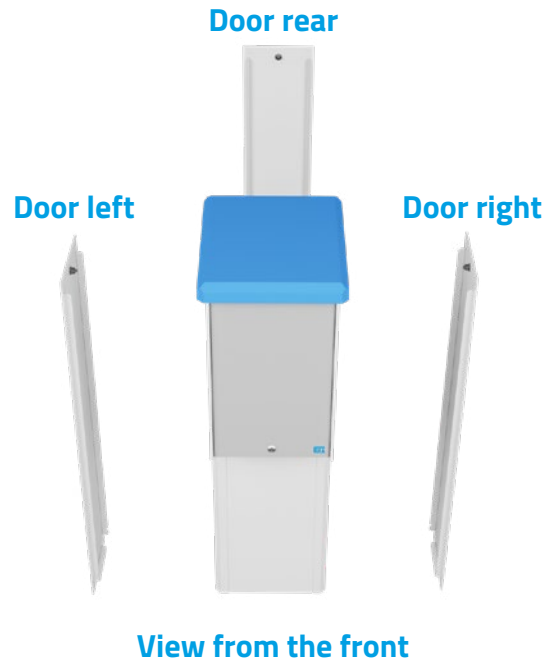

Shelf bottom part, optional

- Install shelf



LED lighting bottom part, optional

- LED lighting

Note:

In addition to the standard colour warm white, the LED lighting can also display the colours red, green, blue and cool white. The connection is made by connecting the the respective strands of the LED strip to the power supply unit.



Custom colours PKW-housing, optional

Note:

Please specify the custom colour for PKW/LKW-housings on page 11.



Custom colour PKW-housing (optional):

- Cover in RAL _____
- Front panel in RAL _____
- Doors in RAL _____
- Housing complete (cover, base, doors (without front panel) in RAL _____

Standard colours:

Housing RAL-9010 (white), textured varnish
Cover RAL-5012 (blue), textured varnish
Front panel RAL-7035 (light grey), smooth varnish











Note:

The paint is applied as a wet paint over the existing powder coating.

Installation service top part, optional

Please indicate the amount and the position per item:

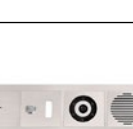
	Item no.	Type	Amount	Spacing from left / spacing from the top edge
	608 000 002	Key switch STUP, flush mounting with cylinder and 3 keys		
	608 000 006	Key switch, STAZ, OPEN-CLOSE, flush mounting with cylinder and 3 keys		
	608 000 015	Key switch, STR, one-side lockable, flush mounting e.g. for CONSTANT OPEN, with cylinder and 3 keys		
	608 000 012	Key switch, STTR, impulse and lockable, flush mounting e.g. for CONSTANT OPEN or CONSTANT CLOSE, with cylinder and 3 keys		
	608 004 000	Token acceptor, mechanical for 1 token 25mm with gooves		
	608 006 001	Additional keyboard for code switch with stainless steel keypad, vandalism protected For further accessories see price list page 64		
	608 007 000	Magnetic key reader, flush mounting with 2 keys		
	608 002 000	Card reader ZUKO ID ZK/A contactless card reader with integrated antenna, for 199 transponder-cards For further accessories see price list page 68		
	608 002 006	RFI reader 80 IP 65, decoder RFI 1000 required For further accessories see price list page 68		
	608 008 021	IP video intercom system for car access, made of aluminum, modular construction with 4 interchangeable function modules, built-in camera for image transmission, with illuminated labeling field		

 Further accessories can be found in our price list.

Installation service top part, optional

Note:

- Installation depth 400mm
- Distance between the cut-outs min. 10mm
- Cut-out with custom shape (e.g. logo) upon request

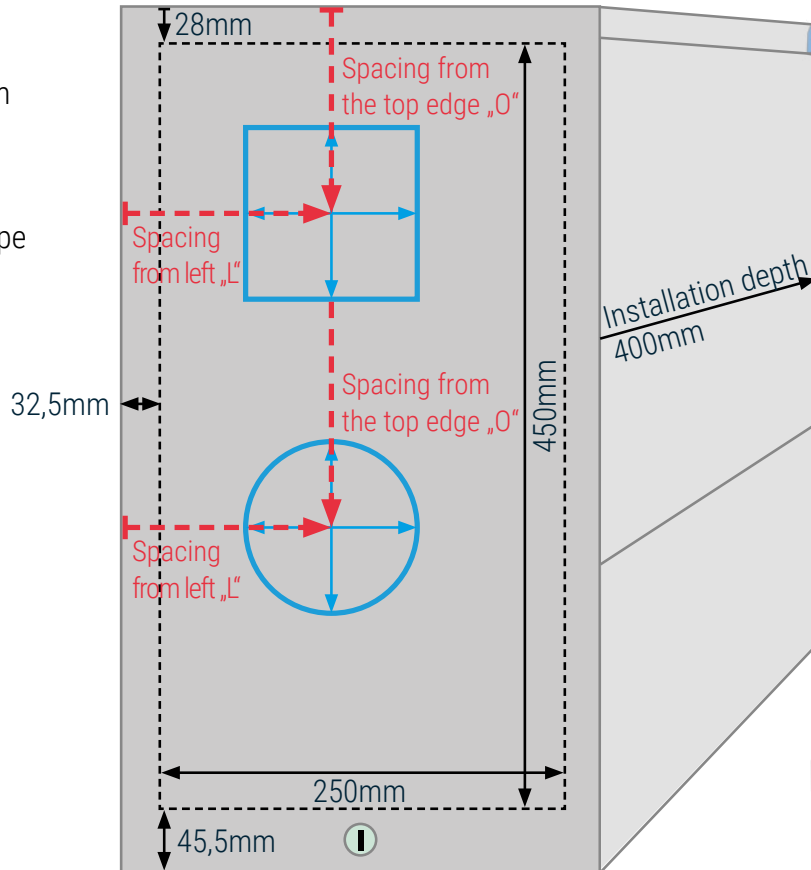

Have ELKA items installed:

Please specify item and position:

Item: _____, spacing from the top edge: _____, spacing from left: _____

Item: _____, spacing from the top edge: _____, spacing from left: _____

Have provided item installed (without wiring):

Item: _____, spacing from the top edge: _____, spacing from left: _____

Item: _____, spacing from the top edge: _____, spacing from left: _____

Have a cutout made:

Dimension of cut-out 1: _____ (width x height or diameter),

spacing from the top edge: _____, spacing from left: _____

Dimension of cut-out 2: _____ (width x height or diameter),

spacing from the top edge: _____, spacing from left: _____

Service-doors top part



Standard lock



Swivelling lever lock

1. Door, standard:

Indicate the door position:

- left (Standard position)
- right
- rear

Choose a door lock:

- Standard lock
- Swivelling lever lock, optional

2. Door, optional:

Indicate the door position:

- left
- right
- rear

Choose a door lock:

- Standard lock
- Swivelling lever lock, optional

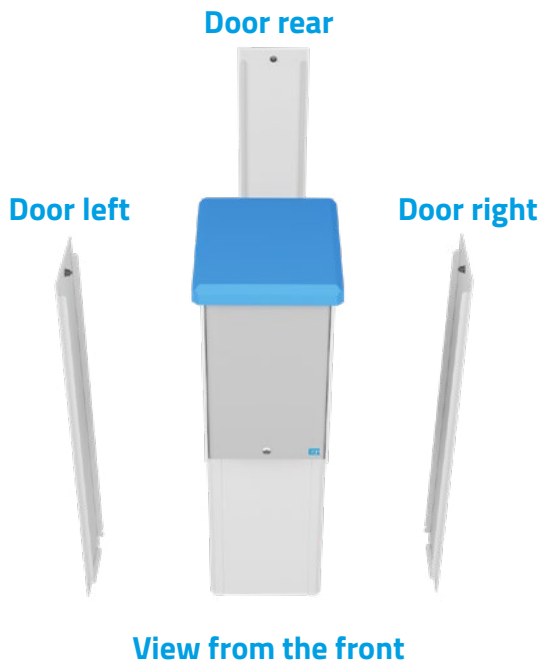

Note:

For the PKW/LKW housing, the door of the upper part cannot be placed above the front panel of the lower part. Please consider the door position when the upper part is mounted rotated.

Shelf top part, optional

- Install shelf



LED lighting top part, optional

- LED lighting

Note:

In addition to the standard colour warm white, the LED lighting can also display the colours red, green, blue and cool white. The connection is made by connecting the respective strands of the LED strip to the power supply unit.



Custom colours PKW/LKW-housing, optional

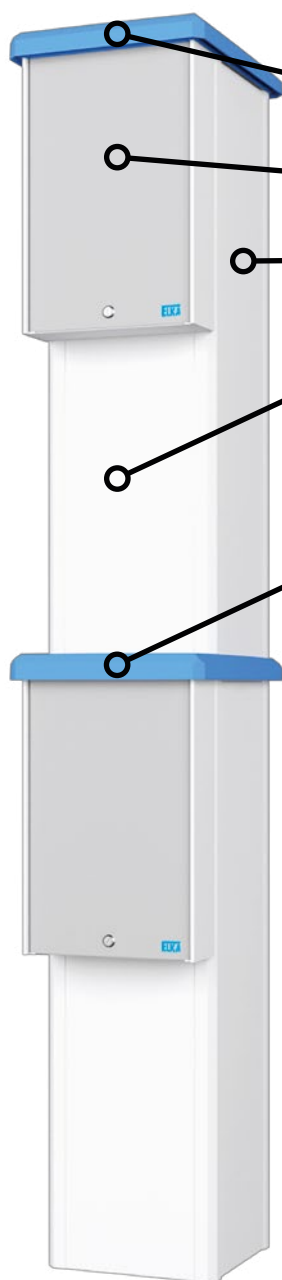

Custom colour PKW/LKW-housing (optional):

- Cover in RAL _____
- Front panel in RAL _____
- Doors - top and bottom in RAL _____
- Base - top and bottom (without doors) in RAL _____
- Housing complete (cover, intermediate cover, base, doors (without front panel) in RAL _____
- Intermediate cover in RAL _____

Standard colours:

Housing RAL-9010 (white), textured varnish
Cover and intermediate cover RAL-5012 (blue), textured varnish
Front panel RAL-7035 (light grey), smooth varnish



Note:

The paint is applied as a wet paint over the existing powder coating.

Technical data	Aluminium-housing PKW 1200-v2.0	Aluminium-housing PKW/LKW 2400-v2.0
Dimensions max. (W x D x H) in mm	379 x 486 x 1,200	379 x 486 x 2,386
Assembly dimensions (W x D x H) in mm	250 x 400 x 450	each 250 x 400 x 450
Weight in kg	30.5	60
Service door, position	Standard on the left side (view from the front)	
Degree of protection	IP 54	
Material	Housing: aluminium, powder-coated Base plate: steel, hot-dip galvanized	
Colours	Housing RAL-9010 (white) / Cover RAL-5012 (blue) / Front plate RAL-7035 (light grey), optionally available in all RAL custom colours	
Accessories (optional)	LED lighting under the cover, clips for variable cable routing, power supply	

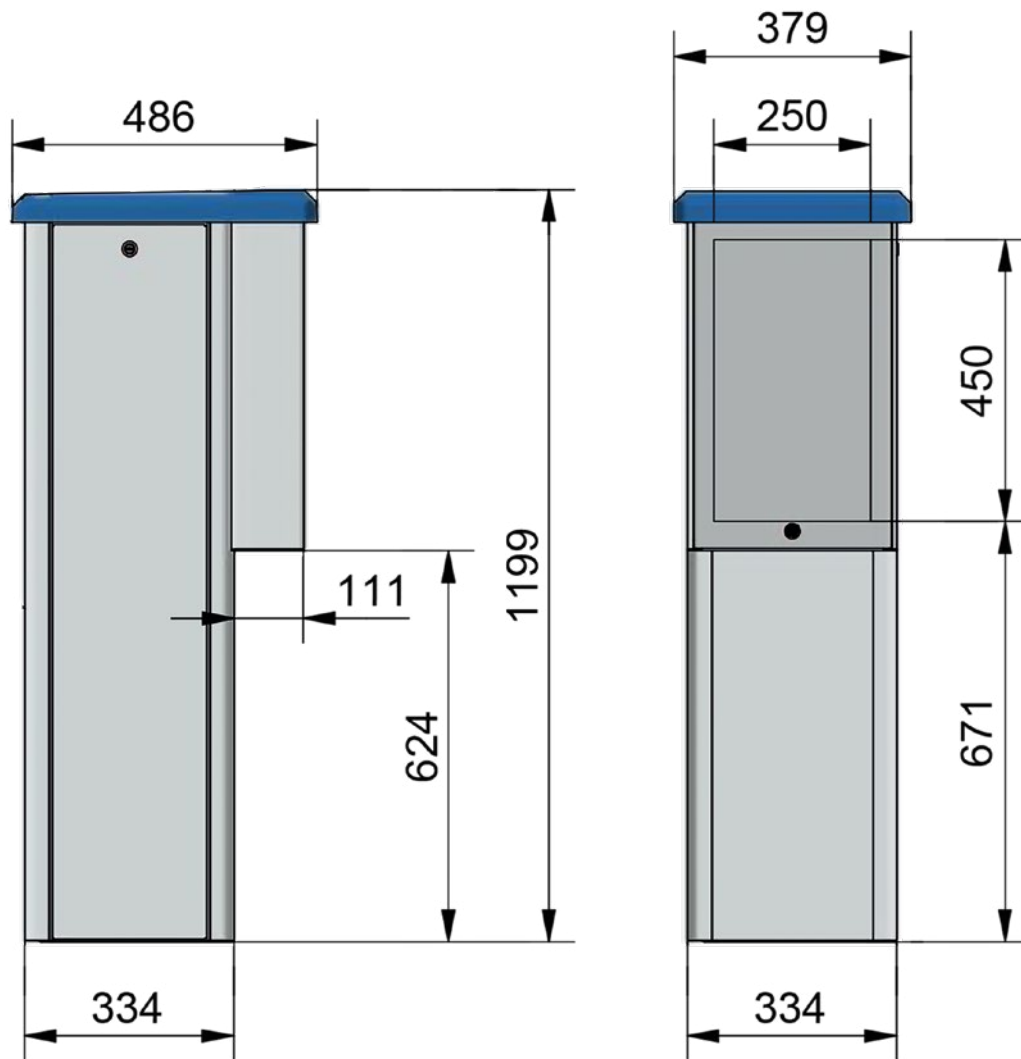

All dimensions in mm.

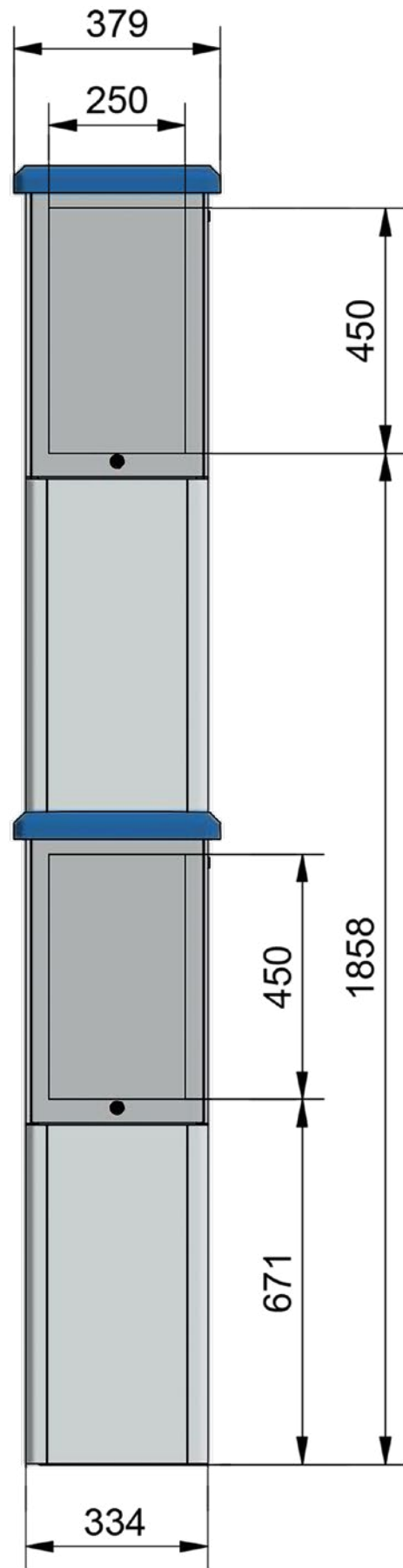
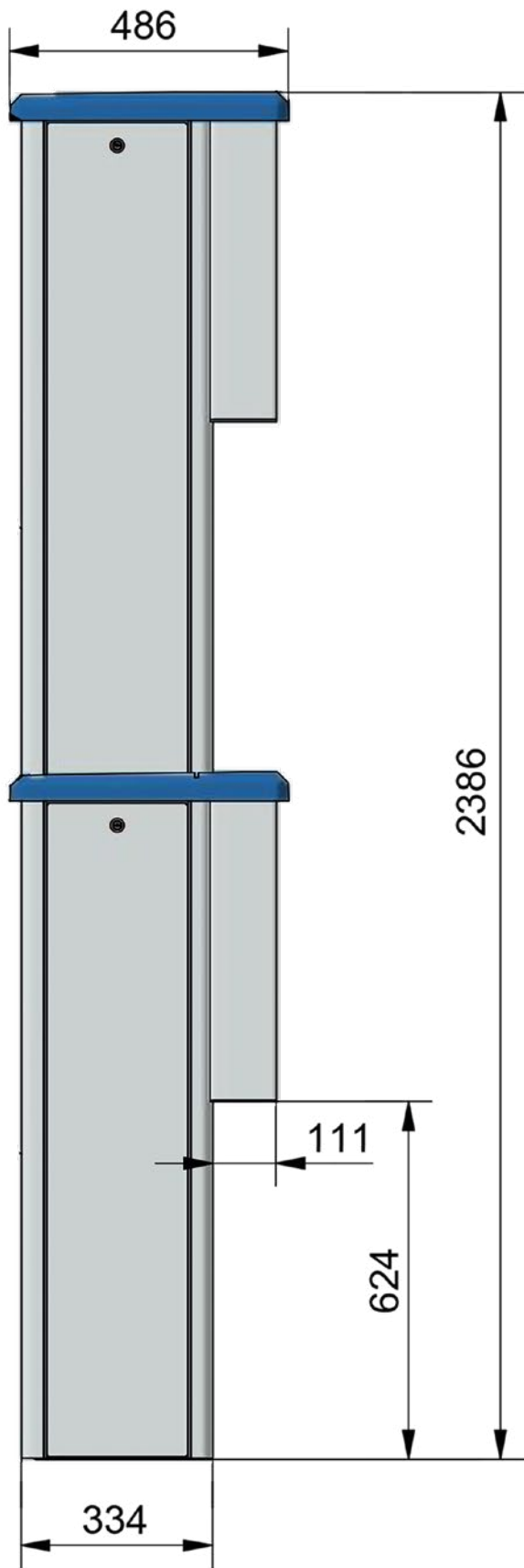

All dimensions in mm.

Foundation dimensions

Note:

The illustration shows the minimum foundation dimensions, which must be adjusted according to the application and local conditions. Please refer to the installation instructions.

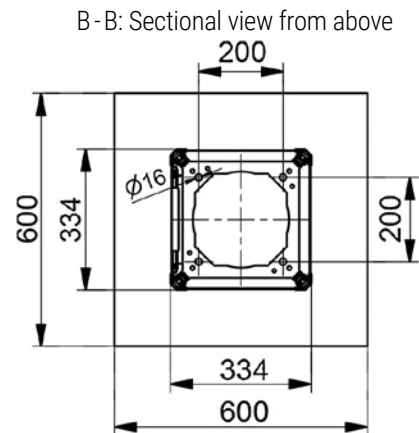
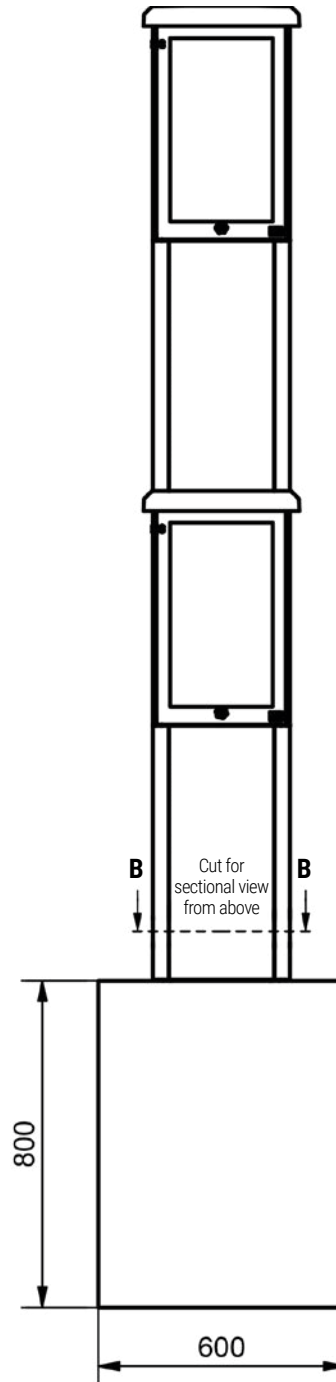
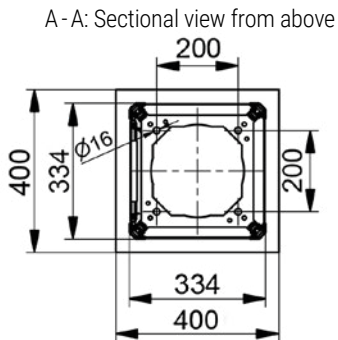
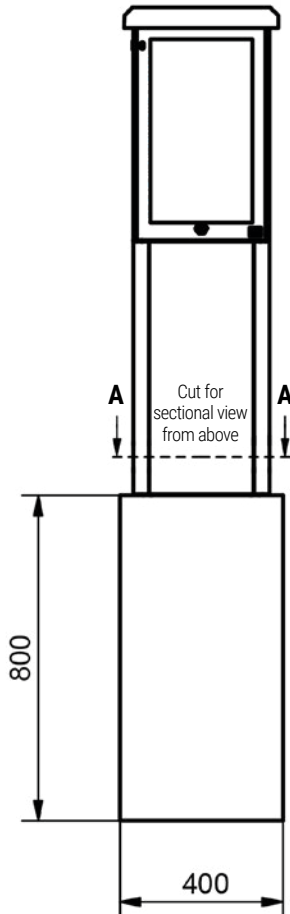

All dimensions in mm.

Your contact information

Customer number:

Company:

Address:

Street address: _____

Postcode/City: _____

Country: _____

Contact person:

Name: _____

Phone: _____

E-Mail: _____



ELKA-Torantriebe GmbH u. Co. Betriebs KG
Dithmarscher Str. 9, 25832 Tönning / Germany

 **info@elka.eu**

 **+49(0)4861-9690-0**

 **www.elka.eu**

 **+49(0)4861-9690-90**